

Design of Basic Vital Signs Measurement Tool and Dehydration Early Detection in Human Body

Efrizon ^{a,1*}, Gwo Jia Jong ^{b,1}, Hendrick ^{a,2}, Fadhlan ^{a,3}, Yulastri ^{a,3}

^a Department of Electrical Engineering, Politeknik Negeri Padang, Indonesia

^b Electronic Engineering, National Kaohsiung University of Science and Technology, Taiwan

¹ efrizon@pnp.ac.id

* corresponding author

ABSTRACTS

A tool has been made to monitor vital signs such as heart rate, oxygen saturation in the blood, and body temperature based on a microcontroller which is based on dehydration conditions where the body loses more fluid than the amount of fluid it enters. Parameters for carrying out this detection include heart rate, blood oxygen saturation (SpO₂), body temperature and urine color. The targets of this research are (a) making a prototype, (b) programming the system with the help of the Arduino IDE, and (c) measuring system performance. The research method starts from making a prototype and measuring system performance. The results of measuring the performance of the tool show that the error for measuring heart rate is 1.28%, measuring blood oxygen saturation (SpO₂) is 0.51%, and measuring body temperature is 1.729%. However, for the dehydration detection test from 5 test samples, the results showed a success percentage of 60% with an average error of 40%. Overall the tool can function well.

ARTICLE INFO

Article history

Received March 15, 2023

Revised April 27, 2023

Accepted June 30, 2023

Keywords

Dehydration, max30100

sensor, GY90614MLX

sensor, TCS3200 sensor

1. INTRODUCTION

Dehydration is a condition when the body loses more fluid than the amount of fluid it enters. If you don't get enough fluids, the body cannot function normally and can trigger various complications [1][2]. A study showed that out of 185 people, 48% of adults were dehydrated and 26% of them did not realize it [3]. In Indonesia, based on research that has been conducted, the number of teenagers who experience mild dehydration is higher than adults, namely 49.5% for teenagers and 42.5% for adults [4]. When the human body is dehydrated, it can be identified by measuring basic vital signs such as pulse rate, oxygen saturation in the blood (SpO₂). This statement is based on the results of consultations with several informants who are general practitioners and are doctors from the Hallodoc application, namely: "When experiencing dehydration, heart rate and pulse will increase (especially when experiencing moderate to severe dehydration) with oxygen saturation levels in the blood (SpO₂) when experiencing mild and moderate dehydration > 95%. This means that when you experience mild or moderate dehydration, the oxygen saturation level in your blood is still relatively normal. However, oxygen saturation in the blood will decrease if there is interference with heart function and respiratory system function. Referring to people's unconsciousness of experiencing dehydration, in this research a simple tool was designed, namely a tool that can be used by everyone to detect early whether there is enough fluid in the body or not. To be able to detect dehydration, this study uses the following measurement parameters: 1) Basic vital signs: heart rate and body temperature and 2) Urine Color. These variables will be a reference for building a tool to measure vital signs and early detection of dehydration in the body. For dehydration detection, the data will be processed using the sample data collection method. then divide the samples based on urine classification classes. To be able to determine the classification class, we can look at the color palate as a reference for classifying samples. Related research has been carried out previously, to detect heart rate [5][6], body temperature [7][8] and urine detection [9][10]. Based on a number of research results, a tool for measuring basic vital signs and early detection of dehydration in the human body was manufactured using a microcontroller-based system. Schematic diagram of basic vital signs measurement tools and early detection of dehydration, as shown in Figure 1.

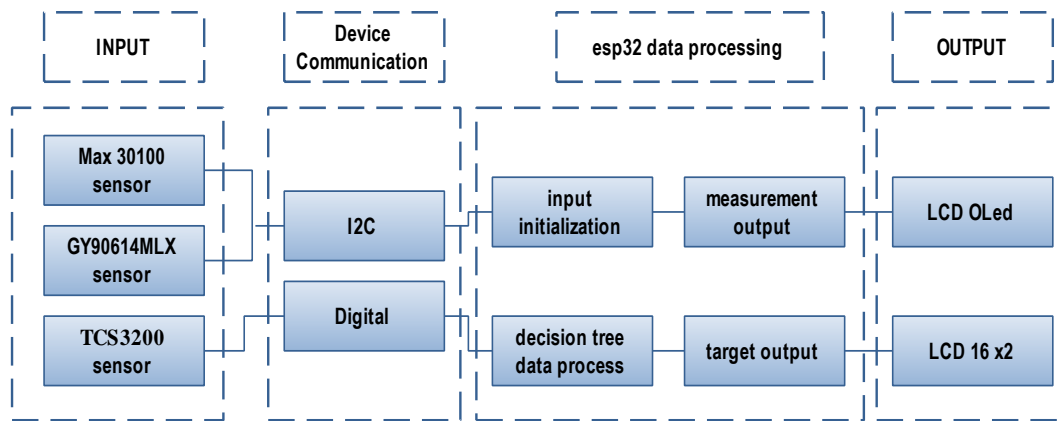

FIG 1. Block Diagram System for measuring basic vital signs and early detection of dehydration in the human body

Based on Figure 1, it can be explained, the tool designed is used to measure heart rate parameters, oxygen saturation levels in the blood, body temperature, and observe the color of urine to identify early signs of dehydration. In this way, users can routinely monitor their body condition, and if these parameters show abnormalities, users can immediately take the necessary steps, such as increasing their body fluid intake. To calibrate the sensor, in this research, measurements were taken on several samples or experimental objects and compared the measurement results of the instrument with a calibrator or instrument used in the medical world. The calibrator used in this research is a medical device, consisting of: Pulse oximeter, Thermogun, and urine color chart. The aim of this research is to measure basic vital signs and detect early dehydration using a microcontroller and to see basic vital signs and detect dehydration, in order to classify dehydration conditions based on color measurements.

2. RESEARCH METHODOLOGY

A. Hardware Design

This tool operates using direct electric voltage or DC, the voltage source used in the tool is an adapter with a voltage of 12 VDC and a current of 2 A. The MAX 30100 and ESP32 sensor modules are integrated with 4 pins, namely Vcc, Gnd, SDA, and SCL, there is one more pin, namely INT (Interrupt) [11] as shown in Figure 2.

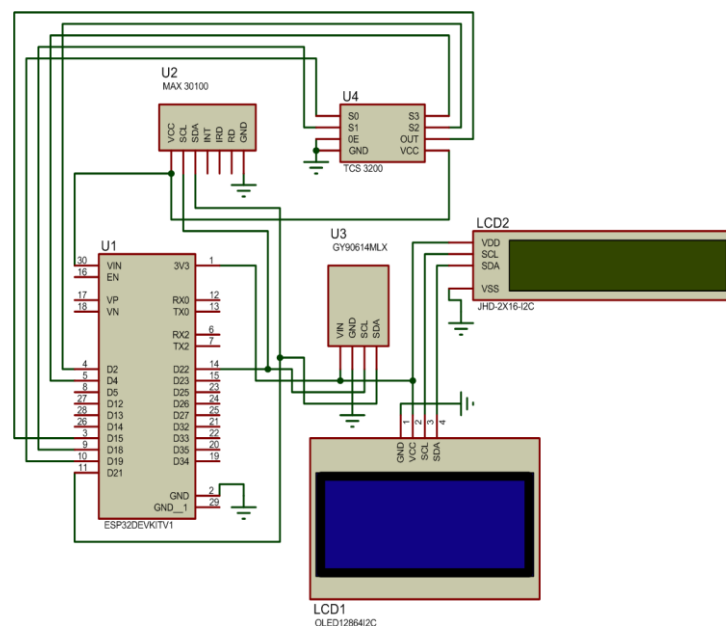

FIG 2. Electronic circuit for measuring basic vital signs and early detection of dehydration in the human body

Based on Figure 2, the GY90614MLX sensor has 4 pins that are connected to the ESP32 microcontroller, namely the Vin, GND, SCL and SDA pins. The GY906MLX sensor uses an I2C interface to read temperature quickly [12]. The TCS3200 sensor circuit has 7 pins which are connected to the Vcc, GND, Out, S0, S1, S2, and S3 pins. The TCS 3200 works at a voltage of 3.3 V [13]. The LCD circuit connected to the SCL pin on the LCD is connected to pin D22 of the ESP32 and the SDA pin on the LCD is connected to pin D21 of the ESP32.

B. Software Design

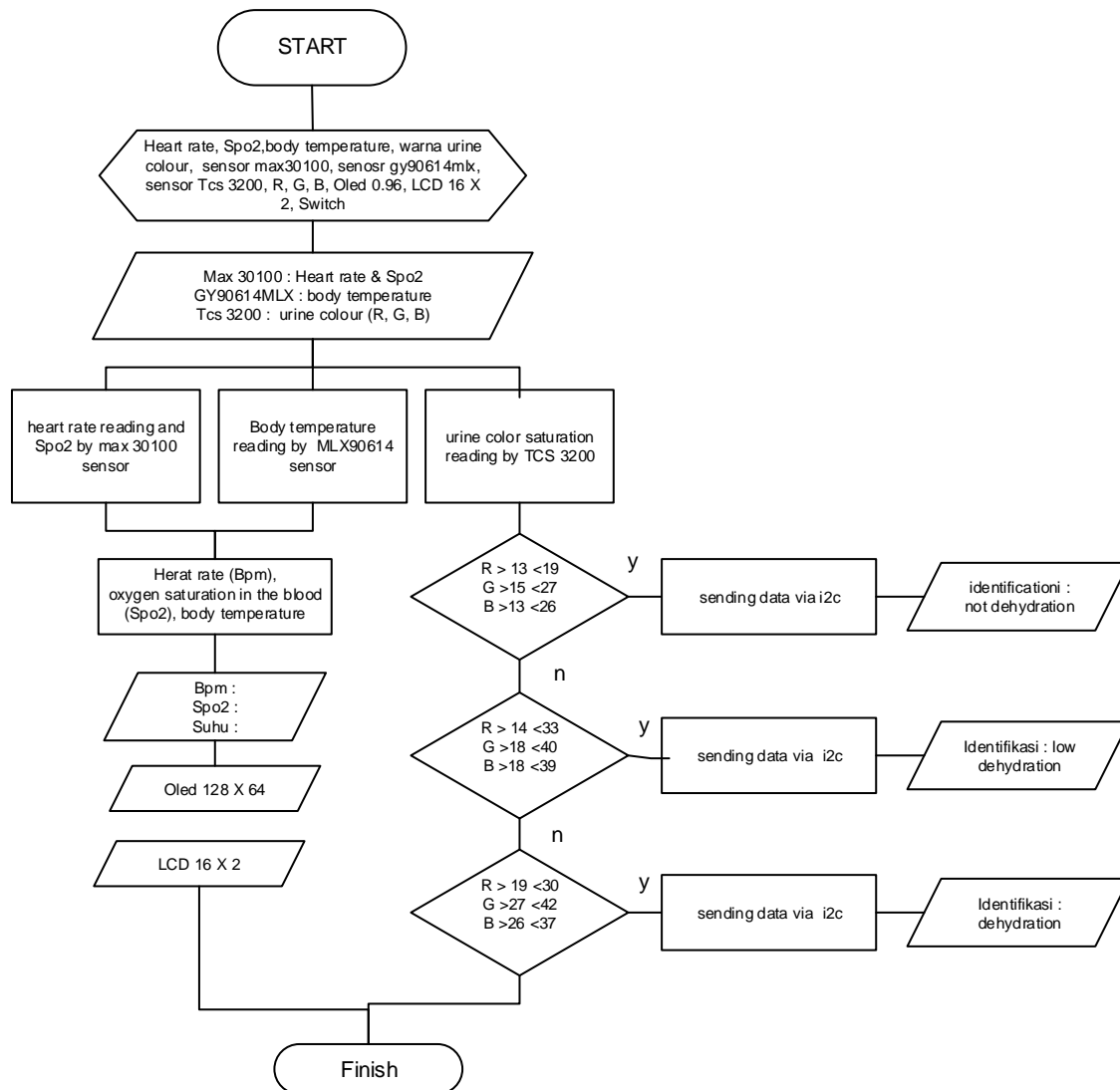

FIG 3. Flowchart for measuring basic vital signs and early detection of dehydration in the human body

Based on Figure 3, it can be explained that the tool works by starting with declaring the components and tools used in the software. Arduino IDE and ESP32 as the microcontroller, the results of the declaration are initialized for input to the MAX 30100 sensor module as measuring heart rate, blood oxygen saturation (Spo2), the GY90614MLX sensor module as measuring body temperature and the TCS 3200 sensor module as measuring urine color. After the initialization process, the sensor takes measurements to obtain input data in the form of heart rate (Bpm), blood oxygen saturation (Spo2), body temperature (°C), and urine color saturation based on Red, Green, Blue. For Bpm, Spo2 and body temperature measurement data, it is processed by the ESP32 microcontroller and displayed on the Oled LCD 128 urine. Then the classification data is displayed on the 16 X 2 LCD. Then the reading of the input parameters will be processed by the microcontroller, there are 2 processes that are followed, namely the first, the sensor input data that is read is sent directly to the Oled LCD, and the second, the input data (parameters) are processed on the microcontroller to get detection results from the condition. measuring object, and then the detection data will be displayed on the 16X2 LCD.

3. RESULTS AND DISCUSSION

The next step is to carry out testing and analysis of the devices that have been created. The main focus at the test results and analysis stage is as follows: (i) Testing and analysis of the MAX30100 sensor module, (ii) Testing and analysis of the GY90614MLX temperature sensor, (iii) Testing and analysis of the TCS3200 sensor,

A. Testing and analysis of the MAX30100 sensor module

The testing process was carried out to verify the MAX30100 sensor's ability to accurately acquire heart rate and blood oxygen levels.



FIG 4. Max30100 Sensor Testing

Figure 4 shows measurements of heart rate and blood oxygen saturation using the MAX30100 module. The MAX30100 module has two types of light produced, namely red light (660 nm) and infrared light (940 nm). Red light is absorbed by oxygenated hemoglobin (HbO₂) and infrared light is absorbed by unsaturated hemoglobin (Hb), resulting in changes in light intensity that are detected by the sensor. Next, the reading results of the MAX30100 Module are compared with the Pulse oximeter. The test results are shown in Table 1.

TABLE 1. Test results of the MAX30100 sensor with a pulse oximeter

Testing	(SpO ₂)		Error %	BPM		Error %
	Pulse Oxymeter	Max 30100		Pulse Oxymeter	Max 30100	
1	99	98	1,010101	101	102,01	0,01
2	96	97	1,04167	73	73,24	0,3
3	95	95	0	74	81,09	9,5
4	95	96	1,05263	82	82,24	0,2
5	96	96	0	92	90,22	1,3
6	95	95	0	88	89,05	1,2
7	96	97	1,04167	99	98,67	0,3
8	98	97	1,020408	82	81,78	0,2
9	96	96	0	82	81,06	1,1
10	96	96	0	98	98,08	0,08

Based on Table 1, after calculating the average % error, it can be observed that there were several measurement processes that produced an error of more than 1%. The error percentage recorded was 1.38%. This sensor has the potential to be used in measuring heart rate and for measuring blood oxygen saturation. However, there are a number of points that need to be considered. Several times during data collection, error values were recorded that exceeded 1%. This is related to the way the finger is placed when taking measurements and the position of the sensor itself. In order for this sensor to function more optimally, it is recommended that the sensor design allows for good finger clamping and is placed in an environment with low light intensity. The goal is for the sensor to only receive infrared light, which will ultimately produce more accurate readings. In the design process of the device that I developed, it turned out that several aspects above were not fully implemented, which resulted in sensor readings having an error rate of around 1.38% for heart rate readings and 0.51% for measuring blood

oxygen saturation. Therefore, in the future development of this device, it is hoped that future developers will consider the aspects mentioned in the device design.

B. Testing and Analysis of the GY 90614 MLX Sensor

The GY90614MLX sensor testing process was carried out by taking sensor data and comparing it with the AICARE brand ThermoGun with a temperature value reading range of 32°C – 42.9°C, which uses the same measurement concept, namely non-invasive or contactless, using infrared radiation.

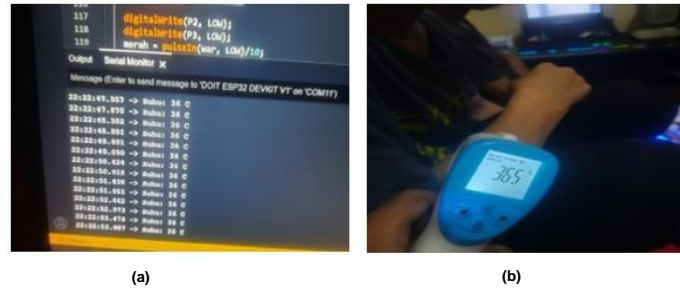

FIG 5. Testing the GY90614 MLX sensor with a ThermoGun under the AICARE brand. (a) reading of the GY90614MLX sensor on a serial monitor, (b) testing with a ThermoGun with the AICARE brand

Based on pictures 5 (a) and 5 (b) test by finding the best position to take measurements. This is a way to calibrate so that sensor readings are obtained properly with minimal error. The testing aspect carried out was testing the sensor reading distance and comparing the thermogun. The test results are shown in Table 2.

TABLE 2.. Sensor Reading Distance Test Data

No	distance (cm)	MLX 90614 °C	Thermo Gun °C
1	0	42	36
2	1	36	36
3	2	35	36
4	3	33	36
5	4	30	36

Based on table 2, the thermogun test is not based on measuring distance, because the thermogun has been determined by measuring results at a distance of 1 – 2 cm from the object. Distance testing is just to test what is a good distance for readings on the GY90614MLX sensor. According to measurements, the best sensor readings are at a distance of 1-2 cm from the GY90614MLX sensor. The GY90614MLX sensor has two infrared sensors that allow it to measure the temperature of the environment as well as the temperature of the detected object. This is possible because the sensor measures the temperature difference between the measurement and reference infrared. When an object is observed, it emits infrared radiation based on the temperature of the object. The higher the temperature of the object, the stronger the radiation. This sensor measures the intensity of radiation emitted by an object, and calculates the temperature difference between the measurement and the reference.

The next testing step involves humans as the object being measured. This test method is carried out by comparing the measurement results from the GY90614MLX sensor with the measurement results using a thermogun at a distance of 1 cm from the object. Thus, the data shown in Table 3 were obtained.

TABLE 3.. Comparison Results of Tools with Thermogun

Testing	Objek		Error %
	Tools (°C)	Thermogun (°C)	
1	35	35	0
2	36	36	0
3	36	35	2,85
4	35	34	2,94
5	35	34	2,94
6	36	36	0
7	35	36	2,77
8	35	34	2,94
9	36	35	2,85
10	35	35	0

Based on Table 3, the values obtained from measuring the GY90614MLX sensor are close to the measurement accuracy as found in calibrator devices. The average reading error on the sensor is 1,729% or 1.7%. %. To increase the accuracy of sensor readings, in the next phase of device development it is recommended to place or design the position of the sensor in such a way on the finger, so that the measurement matches the optimal distance, namely 1-2 cm.

C. Testing and Analysis of the TCS3200 Sensor

The TCS3200 test was carried out by comparing the R G B values, namely the color saturation of Red, Green and Blue. The test uses a color palette consisting of Red, Green and Blue. The testing step is to display the value of the data read on the sensor. Then the value is recorded to get a range of values for that color. Testing of the TCS3200 sensor in this study did not include test data for error values, but only tested the value of color saturation that was read when an object had the color measured on the sensor. After getting the results, then validating the urine reading data where the class of urine condition is obtained to get a classification of the condition of a body that is well hydrated, a body that is dehydrated, and a body that is experiencing severe dehydration, shown in the urine color palette in Figure 6.

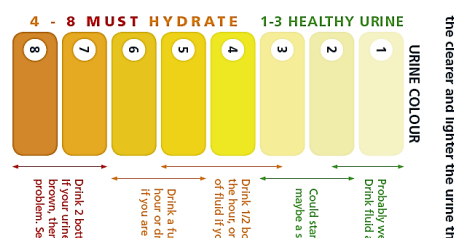

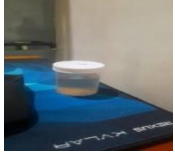





FIG 6. Urine condition palette

Figure 6 published by NHS SOUTH TEES HOSPITAL, NHS Foundation Trust with the title URINE COLOR CHART [14] as valid data for grouping urine color by condition. In this study we validated the classes of urine conditions based on the color above. Urine that is not dehydrated, urine that is dehydrated and urine that is severely dehydrated. This will be the measurement target which is divided into 3 classes, namely not dehydrated, dehydrated and severe dehydration. After that, measure the color saturation of the samples that the author has collected as many as 48 samples. The most difficult sample collection process is a sample of severe dehydration. To obtain a sample of severe dehydration, we precipitate the urine sample for several days so that the color changes to brownish. In general, if you are in good health or you could say that you are not experiencing any problems with your body organs, it will be difficult for a person to reach the stage of severe dehydration, because 70% of the human body is water. For this reason, at least the body consumes minerals, usually the body through urine indicates that we are dehydrated, but not yet severe dehydration. The 48 samples collected were matched with the urine condition palate shown in Figure 4.9 as a benchmark for data on urine condition. Then, after grouping according to the identification target, data was taken on the color saturation R, G, B of the urine. We will later use this data as the measuring range for each class for identification. Sample testing with sensor readings and comparison with color chart data is shown in Table 4.

TABLE 4.. Sample Testing with sensor readings and comparison with color chart data

Sample Testing	Sample urine	reading	result	
			Yes	No
1		not dehydrated		✓
2		dehydration		✓

3		low dehydration	✓
4		Dehidrasi	✓
5		low dehydration	✓

Based on Table 4, test results from 5 urine samples, there were 2 error samples that did not match the sensor readings with the actual urine condition. So that the success of sensor readings is 60% and the average reading error is 40%.

4. CONCLUSIONS

For measuring vital signs in the form of heart rate, oxygen saturation in the blood and body temperature went well, by testing 10 samples, each error for measuring heart rate was 1.28%, measuring Oxygen Saturation in the blood (Spo2) was 0.51% and body temperature is 1.729%. And for the dehydration detection test, from 5 test samples, a success percentage of 60% was obtained with an average error of 40%.

REFERENCES

- [1] E. Loniza, D. C. Dhamayanti, and M. Safitri, "Dehydration urine color detection as human dehydration level based on light emitting diode and light dependent resistors," *J. Robot. Control*, vol. 2, no. 3, pp. 140–144, 2021, doi: 10.18196/jrc.2367.
- [2] E. Y. Mulyani, H. Hardinsyah, D. Briawan, and B. I. Santoso, "The Impact of Dehydration in the Third Trimesters on Pregnancy Outcome-Infant Birth Weight and Length," *J. Gizi dan Pangan*, vol. 13, no. 3, pp. 157–164, 2018, doi: 10.25182/jgp.2018.13.3.157-164.
- [3] A. M. Beck, J. Seemer, A. W. Knudsen, and T. Munk, "Narrative review of low-intake dehydration in older adults," *Nutrients*, vol. 13, no. 9, pp. 1–16, 2021, doi: 10.3390/nu13093142.
- [4] S. Alam and N. I. Majid, "Nutritional Status, Physical Activity, and Fluid Intake with Dehydration Status of Farmers in Jeneponto Regency," *Public Heal. Nutr. J.*, vol. III, no. 1, pp. 43–51, 2023, [Online]. Available: <http://dx.doi.org/10.24252/algizai.v%25vi%25i.35768>.
- [5] B. Wulandari and M. P. Jati, "Design and Implementation of Real-Time Health Vital Sign Monitoring Device with Wireless Sensor-based on Arduino Mega," *Elinvo (Electronics, Informatics, Vocat. Educ.)*, vol. 6, no. 1, pp. 61–70, 2021, doi: 10.21831/elinvo.v6i1.43799.
- [6] R. G. A., S. P., and T. Z. Fadhil, "An efficient IoT based biomedical health monitoring and diagnosing system using myRIO," *Telkomnika (Telecommunication Comput. Electron. Control.)*, vol. 18, no. 6, pp. 3050–3057, 2020, doi: 10.12928/TELKOMNIKA.v18i6.14375.
- [7] A. G. Airij, R. Sudirman, U. U. Sheikh, T. Ide, Y. Nagata, and K. Kamata, "Comparative study on the measurement of human thermal activity," *Int. J. Adv. Sci. Eng. Inf. Technol.*, vol. 9, no. 6, pp. 2160–2165, 2019, doi: 10.18517/ijaseit.9.6.9958.
- [8] Alamsyah, M. Subito, and A. Amir, "Design System Body Temperature and Blood Pressure Monitoring Based on Internet of Things," *2020 3rd Int. Conf. Inf. Commun. Technol. ICOIACT 2020*, pp. 276–279, 2020, doi: 10.1109/ICOIACT50329.2020.9331968.
- [9] H. Prasetyo, F. N. I. Sari, R. N. Hidayati, and R. L. Apriyanto, "Portable urine alcohol detector fabrication with arduino microcontroller-based MQ-3 sensor," *Gravity J. Ilm. Penelit. dan Pembelajaran Fis.*, vol.

- 7, no. 2, pp. 38–45, 2021, doi: 10.30870/gravity.v7i2.11376.
- [10] S. A. Ragul, S. Santhana Bharathi, R. Sreeram, V. Surya Prakash, P. Pandiyan, and S. Saravanan, “Non-invasive method of diagnosing health parameters using urinalysis,” *2020 6th Int. Conf. Adv. Comput. Commun. Syst. ICACCS 2020*, pp. 867–871, 2020, doi: 10.1109/ICACCS48705.2020.9074403.
- [11] K. V. S. S. Ganesh, S. P. S. Jeyanth, and A. R. Bevi, “IOT based portable heart rate and SpO2 pulse oximeter,” *HardwareX*, vol. 11, 2022, doi: 10.1016/j.ohx.2022.e00309.
- [12] I. H. Tanjung, Jufrizel, A. Faizal, and P. S. Maria, “Non Contact Thermometer Using Infrared Temperature Sensor MLX90614 As Body Temperature Measuring Body Based On SMS Gateway Termometer Non Contact Menggunakan Sensor Suhu Infrared MLX90614 Sebagai Pengukur Suhu Tubuh Berbasis SMS Gate Way,” *IJEERE Indones. J. Electr. Eng. Renew. Energy*, vol. 2, no. 1, pp. 19–28, 2022.
- [13] A. Juliano, A. H. Hendrawan, and Ritzkal, “Information system prototyping of strawberry maturity stages using arduino Uno and TCS3200,” *J. Robot. Control*, vol. 1, no. 3, pp. 86–91, 2020, doi: 10.18196/jrc.1319.
- [14] NSW Health, “Urine Colour Chart,” *Urin. Colour Chart*, p. 1, 2013, [Online]. Available: <http://www.health.nsw.gov.au/environment/beattheheat/Pages/urine-colour-chart.aspx>.